

Introduction

Dialogue

1. Ecoute, lis et prononce:

1

Comment t'appelles-tu ?



Je m'appelle Hana.



2

Comment t'appelles-tu ?



Je m'appelle Seif.



3

Comment ça va ?

Quel âge as-tu ?

Ça va bien, merci.

J'ai 9 ans.



2. Ecoute et comprends:

1 Lève-toi



2

Assieds-toi.



3

Ouvre le livre.



4

Ferme le livre.



5

Va au tableau.



6

Va à ta place.



Unité 1

C'est ma classe

Observe et lis:

1 un élève



2 une élève



3 une maîtresse





4 un cahier



5 un crayon



6 un livre



7 un stylo

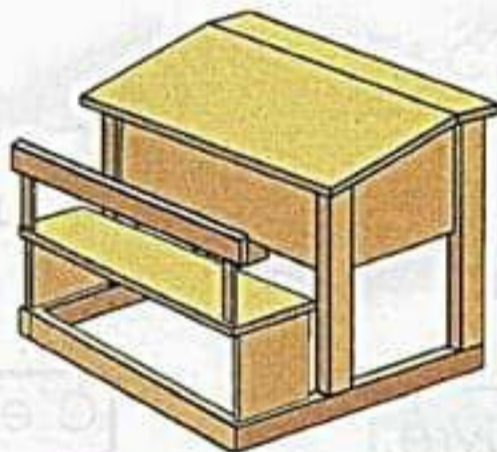

8 un banc



9 une règle



10 une gomme



11 une chaise

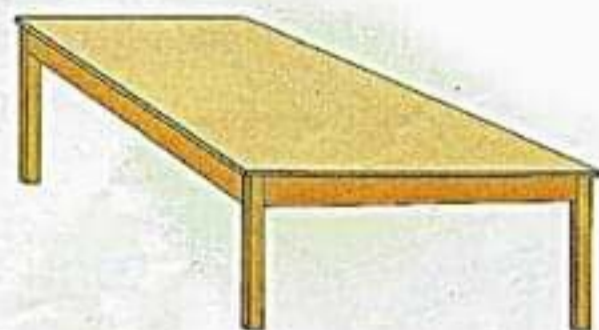

12 une table

1. Note - Bien:

(m) masculin

(f) féminin



un garçon

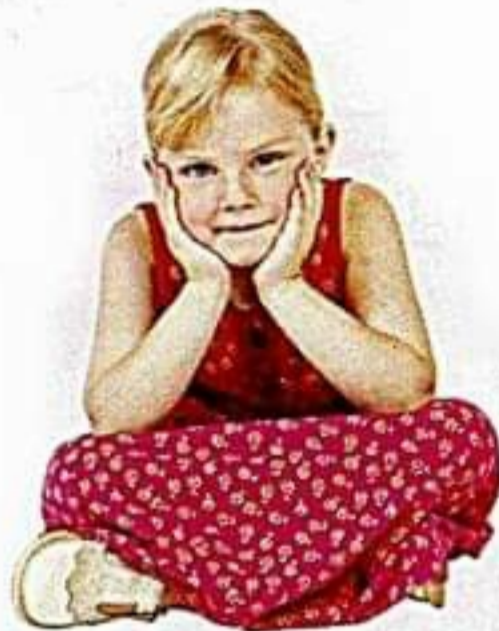

une fille

2. Choisis et prononce:

C'est un livre.

C'est une gomme.



1

un livre

2

une gomme

3

un crayon

4

une règle

5

un banc

6

un stylo

7

une chaise

8

une table



Exercices

1. Complète avec: (un ou une)



1. C'est _____ règle.



2. C'est _____ gomme.



3. C'est _____ maîtresse



4. C'est _____ crayon.



5. C'est _____ stylo.



6. C'est _____ livre.

2. Complète:

1. C'est un _____



2. C'est une _____



3. C'est un _____



4. C'est une _____

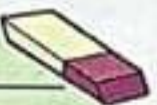

5. C'est un _____



6. C'est une _____



Unité 2

C'est ma maison

Observe et lis:

1 La chambre à coucher



1 un canapé

2 une télévision



1 un buffet



2 une table

3 une chaise

4 La salle de bains

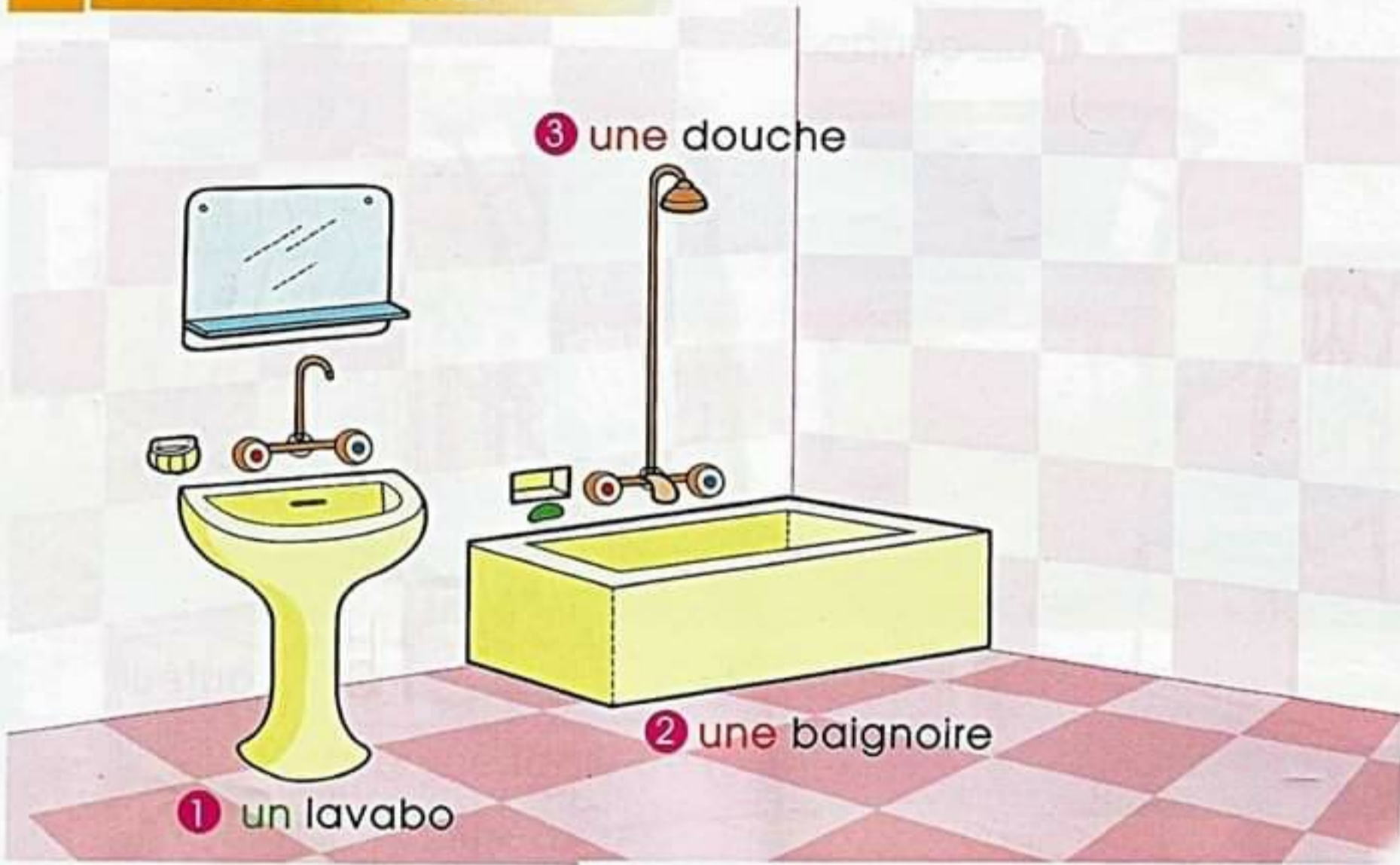

5 La cuisine

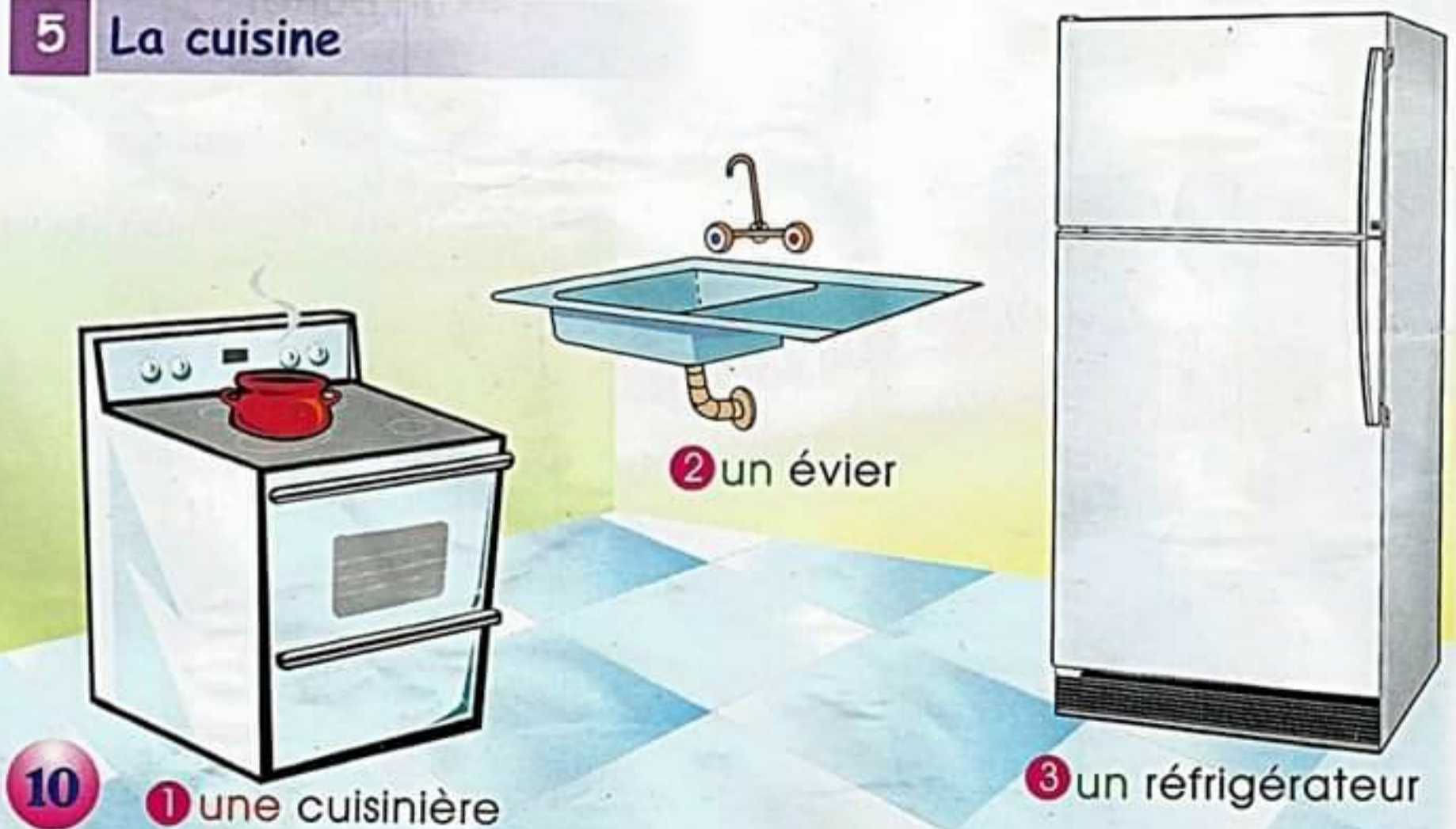

Note-Bien:

(S) singulier (un , une)

(P) pluriel (des)

un tapis 



des tapis 

une table 



des tables 



Exercices

Choisis: (un-une-des)



1. C'est _____ tapis.



2. C'est _____ armoire.



3. C'est _____ cuisinière.



4. C'est _____ réfrigérateur.

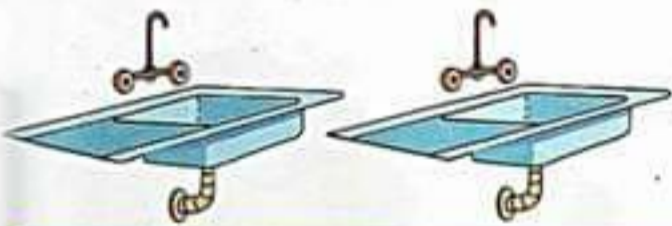

5. Ce sont _____ lavabos.



6. Ce sont _____ télévisions.



7. Ce sont _____ buffets.

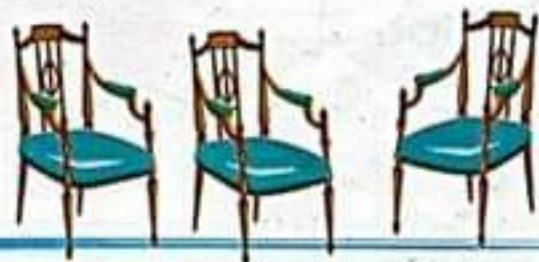

8. Ce sont _____ fauteuils.

Unité 3

Les fruits et les légumes

1. Observe et lis:



1 la pomme



2 la poire



3 la carotte



4 la tomate



5 la pêche



6 le citron



7 le chou



8 la pastèque



9 le chou - fleur

1



la pomme



les pommes



2



la carotte

les carottes



3



le citron



les citrons



4



la pastèque



les pastèques



5



la pomme de terre



les pommes de terre



6



la tomate



les tomates

7



la poire



les poires

8



la banane



les bananes

9



le chou



les choux

10



le chou - fleur



les choux - fleurs



Grammaire

Note-Bien:

(S) singulier

(le) masculin singulier



le citron

(la) féminin singulier



la pomme

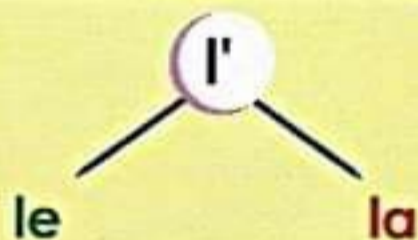

Devant un mot qui commence par une voyelle (a,e,i,o,u,y), je barre la lettre (a) ou la lettre (e).

(m) l'oignon



(f) l'orange



(P) pluriel

(le) masculin singulier → **(les)** masculin pluriel

(la) féminin singulier → **(les)** féminin pluriel

(m) l'oignon



(les) oignons



(f) l'orange



(les) oranges





1. Choisis la bonne réponse: (le-la-l' -les)

1. _____ citron



2. _____ banane



3. _____ choux-fleurs



4. _____ oignon



5. _____ pommes de terre



6. _____ oranges



7. _____ pastèque



8. _____ tomates



2. Ecris dans chaque case la lettre qui convient:

a

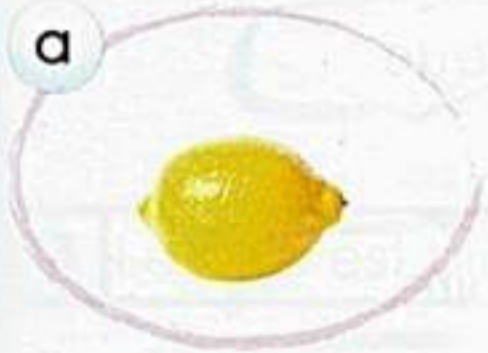

b

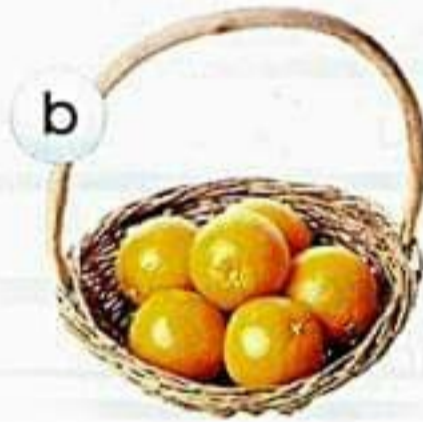

c



d



e



f



1 C'est une pomme. 2 C'est un citron. 3 Ce sont des oranges.

4 C'est une tomate. 5 C est un chou. 6 Ce sont des bananes.

1

2

3

4

5

6

d

Unité 4

Les couleurs

1. Observe et lis: (m) masculin → (f) féminin

1 vert verte

2 gris grise

3 bleu bleue

4 noir noire

5 blanc blanche

2. Note-Bien: (m) masculin = (f) féminin

6 marron marron

7 rouge rouge

8 jaune jaune

9 rose rose

10 orange orange

3. Observe et lis:

(m) masculin



1 Le chou est vert .

(f) féminin



2 La poire est verte .



3 Le livre est blanc.



4 La gomme est blanche.



5 Le stylo est rose .



6 La règle est rose .

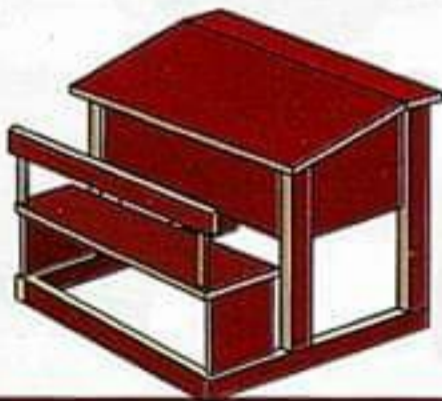

7 Le banc est marron.



8 La chaise est marron.



9 Le citron est jaune .



10 La banane est jaune .

1. Ecoute, lis et prononce:



2. Choisis et prononce:

De quelle couleur est la _____ ?



La _____ est _____

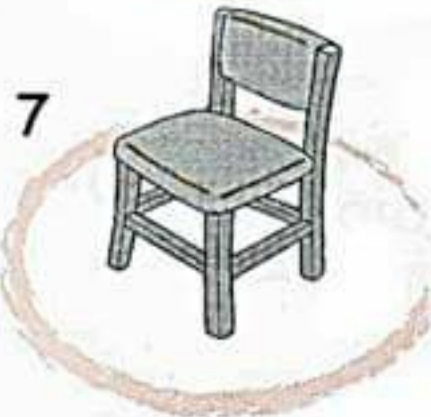
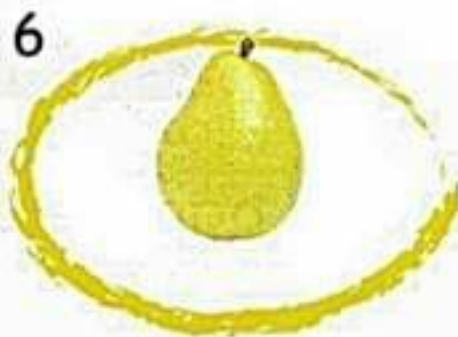
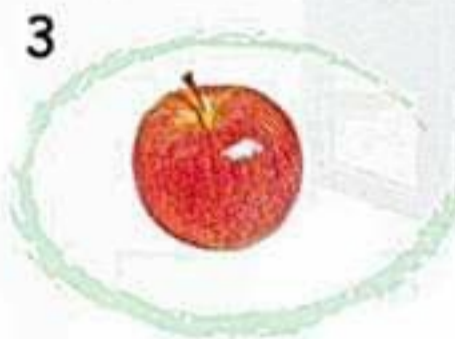
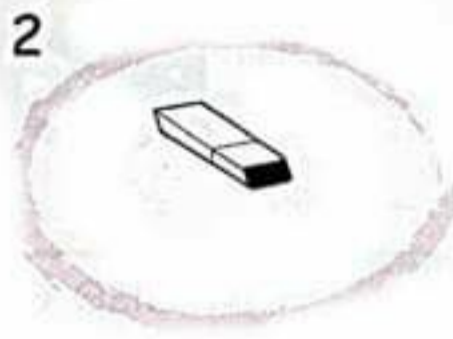

3. Ecoute, lis et prononce:

De quelle couleur est le chou ?



Le chou est vert.



4. Choisis et prononce:

De quelle couleur est le _____ ?



Le _____ est _____



1



2



3



4



5



6



7

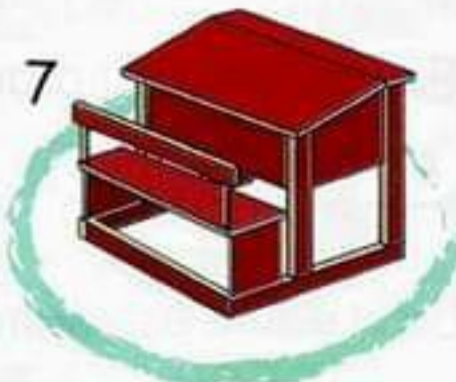

8



1. Note-Bien:

(S) singulier

(P) pluriel



(m) masculin

(f) féminin

(m) masculin

(f) féminin

	vert	➡	verte	verts	➡	vertes
	bleu	➡	bleue	bleus	➡	bleues
	noir	➡	noire	noirs	➡	noires
	gris	➡	grise	gris	➡	grises
	blanc	➡	blanche	blancs	➡	blanches

	rouge	➡	rouge	rouges	➡	rouges
	jaune	➡	jaune	jaunes	➡	jaunes
	rose	➡	rose	roses	➡	roses

2. Attention: Les couleurs (orange) et (marron) ne changent pas au pluriel.

 orange ➡ orange orange ➡ orange

Ex: La robe est orange. Les robes sont orange.

 marron ➡ marron marron ➡ marron

Ex: Le livre est marron. Les livres sont marron.

3. Choisis et prononce:

Les livres sont rouges.



Les gommes sont blanches.

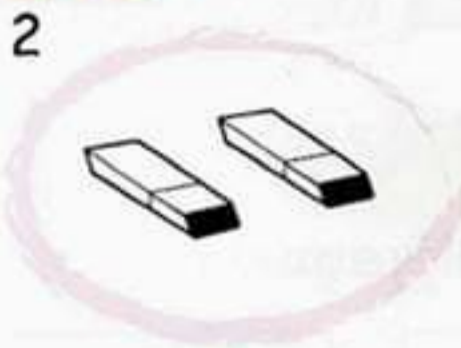

Exercices

Complète:



1 La tomate est _____



2 Les tomates sont _____



3 Le citron est _____



4 Les citrons sont _____



5 La carotte est _____



6 Les carottes sont _____



7 La banane est _____



8 Les bananes sont _____

Unité 5

Le petit déjeuner

1. Observe et lis:



1. l'assiette



2. la cuillère



3. la fourchette



4. le couteau



5. la confiture



6. les oeufs



7. le lait



8. le pain



9. le fromage

Chaque matin,
je prends mon petit déjeuner :
je mange du pain avec du beurre
ou de la confiture, des oeufs et
du fromage. Et, je bois du lait.





Note-Bien:

(du) masculin

(de la) féminin

(du) / (de la) = un peu de

du
de la

placés après les verbes (manger- prendre) sont des articles partitifs

Ex: Je mange du pain, de la confiture

Je prends du pain, de la confiture



Je prends le pain.



(du) Je prends du pain.



Je prends la confiture



(de la) Je prends de la confiture.



Exercices

1. Complète avec: (pain, confiture, lait, beurre)



Pour le petit déjeuner, Noha prend

du  _____

avec du  _____

ou de la  _____

Et, elle boit du  _____

2. Choisis la bonne réponse: (de la-du-des)

1 Sami boit _____ lait.

2 Hana mange _____ oeufs.

3 Je mange _____ confiture.

4 Mona mange _____ pain.

5 Nadi mange _____ fromage.

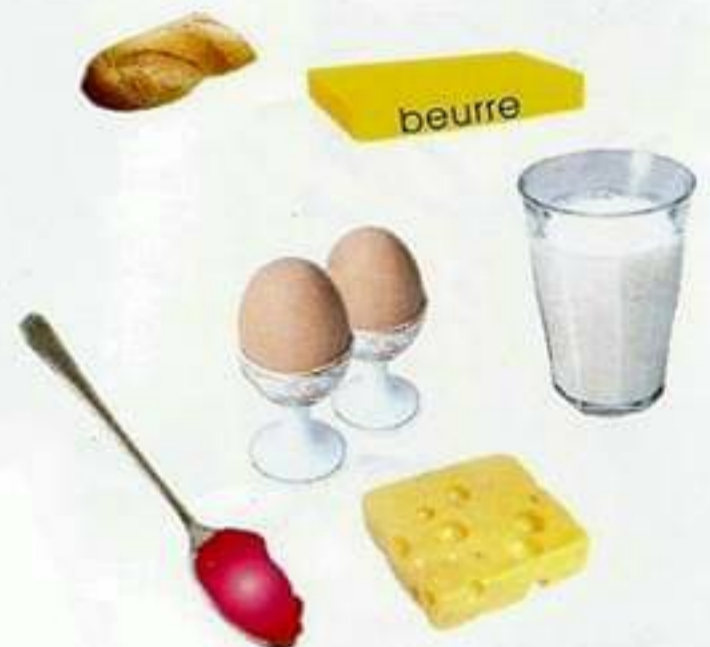

Unité 6

Les animaux

1. Observe et lis:

A

1 la girafe



2 le zèbre



3 l'éléphant



4 le tigre



5 l'ours



6 le lion



1 le cheval



3 la vache



4 le chat



5 le lapin



6 le chien



7 le mouton



3 le cheval

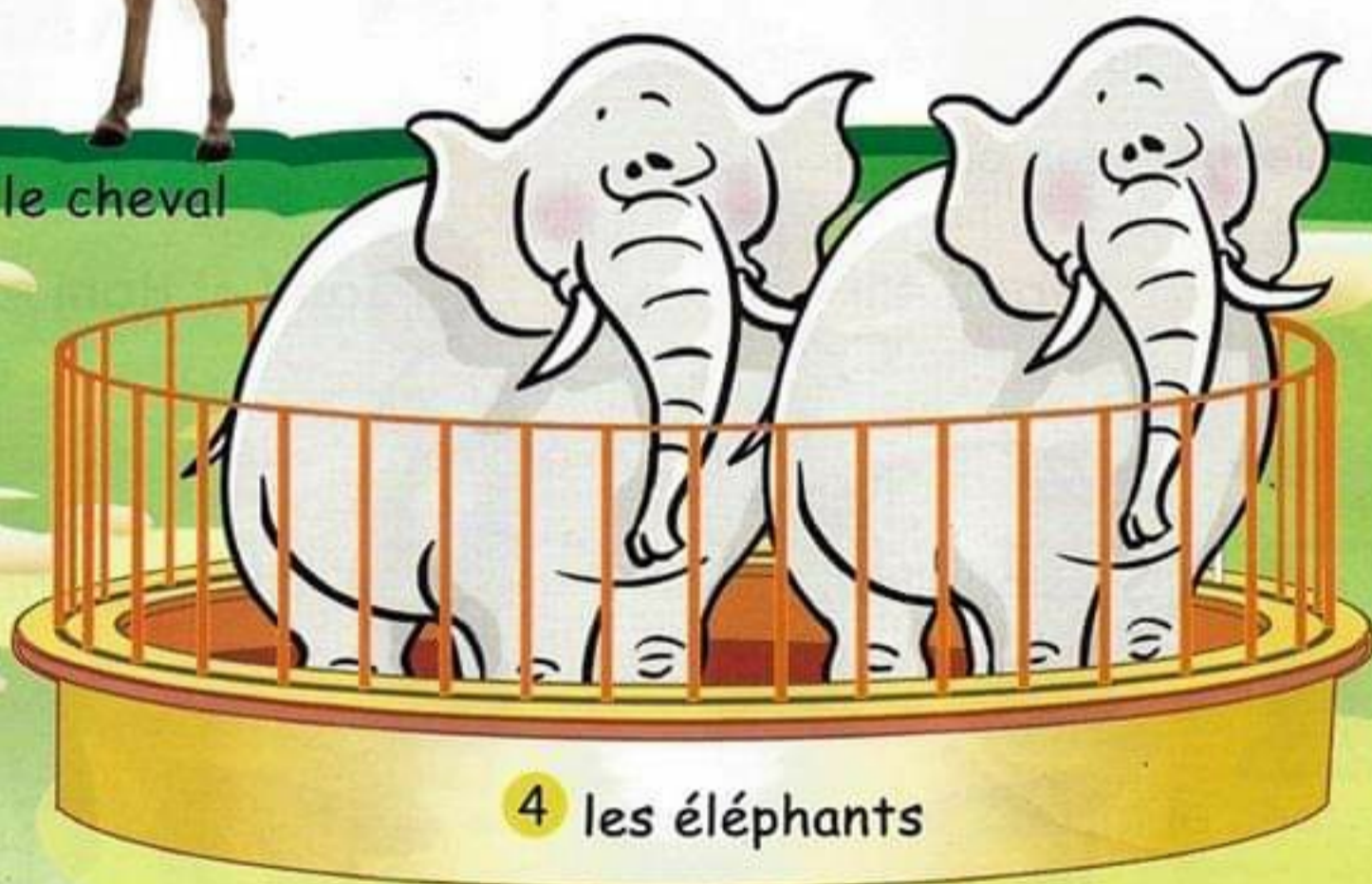

4 les éléphants



5 les lions



6 les tigres

1. Note - Bien:

(m) Masculin

(S) singulier



il

Sami = il

(P) pluriel



ils

Sami et Hani = ils

(f) Féminin

(S) singulier



elle

Sara = elle

(P) pluriel



elles

Sara et Nour = elles

2. Attention:



ils

Sami et Sara = ils



ils

Sara, Sami et Nour = ils

Complète avec: (il, ils, elle, elles)

1



Ahmed mange des bananes.

_____ aime les bananes.

2



Mona aime les oranges.

_____ mange des oranges.

3



Hend et Ali regardent le chien.

_____ aiment le chien.

4

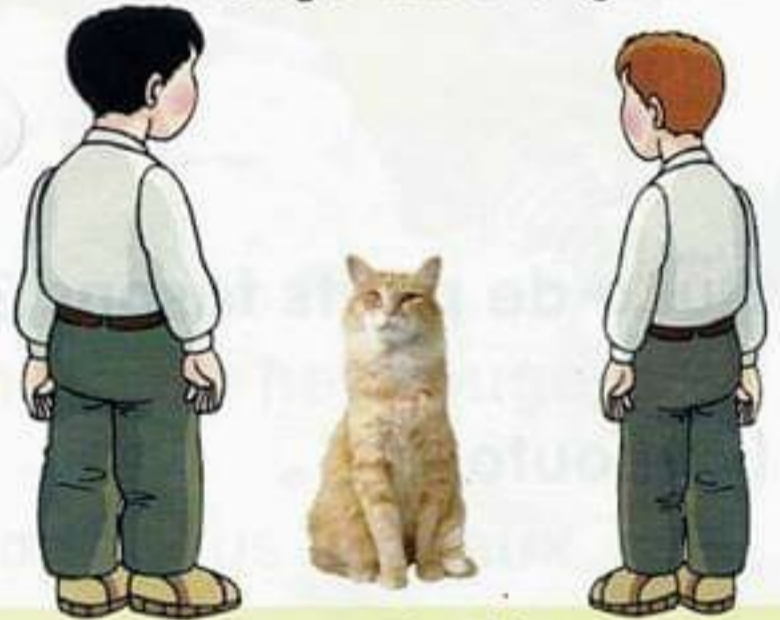

Sami et Ali regardent le chat.

_____ aiment le chat.

5

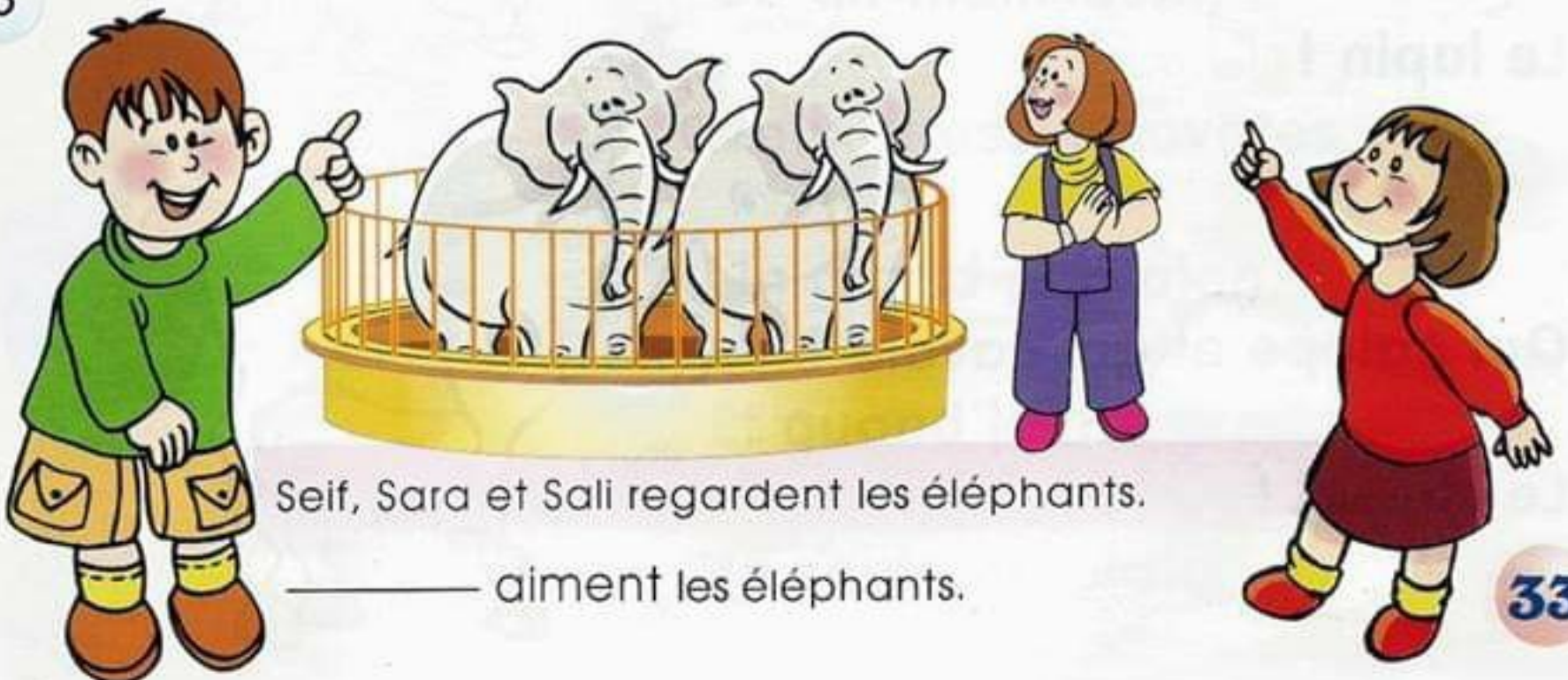

Seif, Sara et Sali regardent les éléphants.

_____ aiment les éléphants.

Chanson



Les animaux

Qui est blanche avec des taches?

C'est la vache ! 



Qui a de petits frisons ?

Le mouton ! 

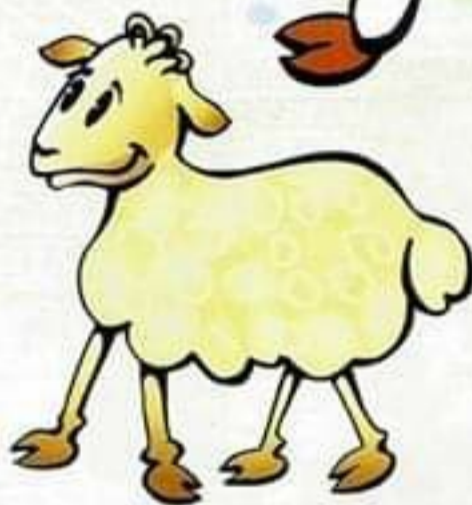

Qui est doux comme un lapin ?

Le lapin ! 



Qui galope et qui cavale ?

Le cheval ! 



Chanson



Le clown



J'ai un grand nez rouge,

Des traits sous les yeux,

Un chapeau qui bouge,

Un air malicieux.

Deux grosses savates,

Un grand pantalon,

Et quand je me gratte,

Je saute au plafond.

Chanson

La chanson du chat



Chat, chat, chat,
Chat noir, chat blanc, chat gris,
Charmant chat couché,
Chat, Chat, Chat,
N'entends-tu pas les souris
Danser à trios des entrechats
Sur le plancher?
Le bourgeois ronfle dans son lit,
De son bonnet de coton coiffé,
Et la lune regarde à la vitre.
Dansez, souris, dansez, jolies.



Dictionnaire alphabétique

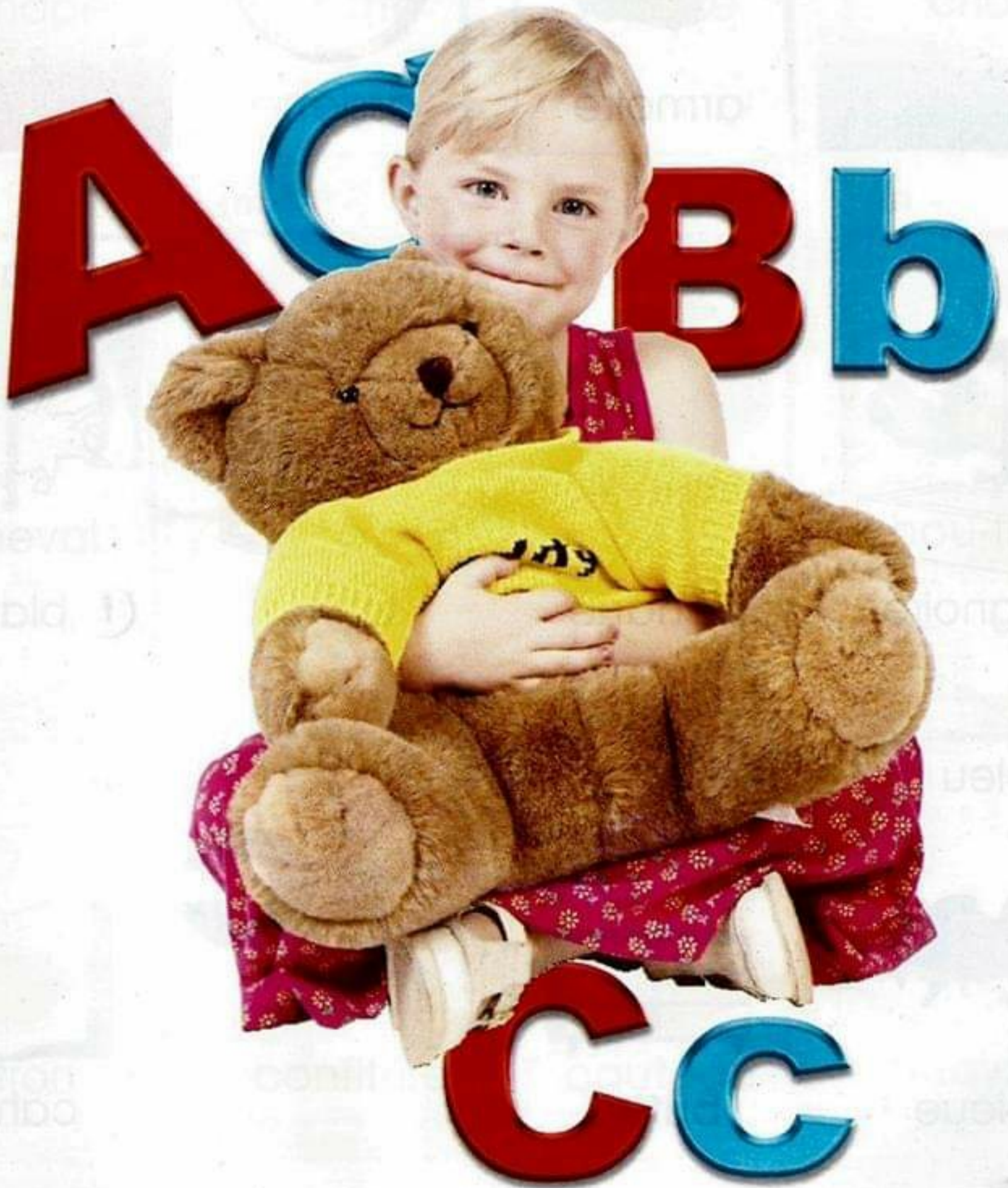

Aa

(f)



armoire

(f)



assiette

Bb

(f)



baignoire

(f)



banane

(m)

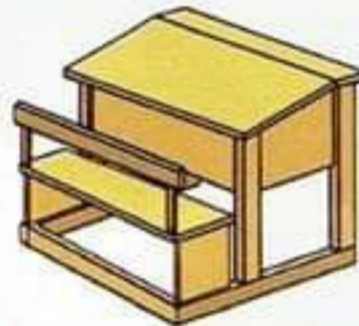

banc

(m) blanc



(f) blanche

(m) bleu



(f) bleue

(m)

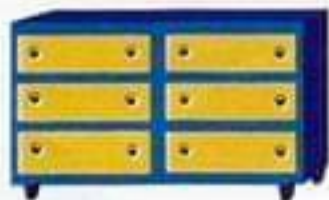

buffet

Cc

(m)



cahier

(m)



canapé

(f)



carotte

(f)



chaise

(m)



chat

(m)



cheval

(m)



chien

(m)



chou

(m)



chou-fleur

(m)



citron

(f)



confiture

(m)



couteau

(m)



crayon

(f)



cuillère

(f)



cuisinière

D d



(f)



douche

E e

(m)



éléphant

(m)



(f)



élève

(m)



évier

F f

(m)



fauteuil

(f)



fille

(f)



fourchette

(m)



fromage

Gg

(m)



garçon

(f)

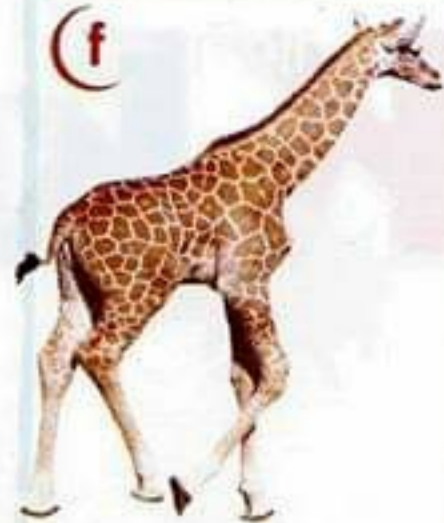

girafe

(f)



gomme

(m) gris



(f) grise

Hh

(m)





Jj

(m) jaune



(f) jaune

Kk



Ll



(m)



lait

(m)



lapin

(m)



lavabo

(m)



lion

(m)



lit

(m)



livre

Mm



(f)



maison

(f)



maîtresse

(m) marron



(f) marron

(m)



mouton

Nn



(m) noir



(f) noire

Oo

(m)



oeuf

(m)



oignon

(f)



orange

(m) orange



(f) orange

(m)



ours

Pp



(m)



pain

(f)



pastèque

(f)



pêche

(m)



perroquet

(f)



poire

(f)



pomme

(f)



pomme de terre

Qq



Rr

(m)

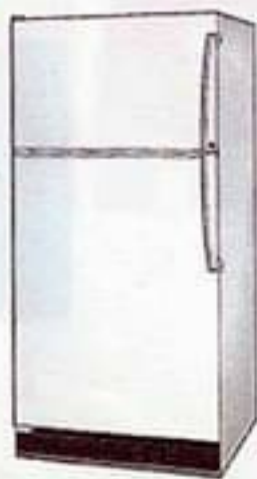

réfrigérateur

(f)



règle

(m)



rideau

(m) rose



(f) rose

(m) rouge



(f) rouge

Ss



(m)



stylo

Tt



(f)



table

(m)



tableau

(f)



table de toilette

(m)



tapis

(f)



télévision

(m)



tigre

(f)



tomate

Uu



Vv

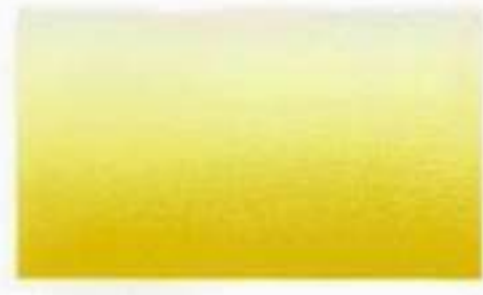

(f)



vache

(m) vert

Ww



Xx



(f) verte



Yy



Zz



(m)



zèbre

Table des matières

pages

Introduction

2

Unité 1

C'est ma classe

4

Unité 2

C'est ma maison

8

Unité 3

Les fruits et les légumes

12

Unité 4

Les couleurs

18

Unité 5

Le petit déjeuner

24

Unité 6

Les animaux

28



Chansons

34



Dictionnaire alphabétique

38